

PERFORMANCE OF BPM READOUT ELECTRONIC BASED ON PILOT-TONE GENERATOR AND A MODIFIED LIBERA SPARK AT ALBA

L. Torino*, U. Iriso, ALBA-CELLS, Cerdanyola del Vallès, Barcelona, Spain

Abstract

As many synchrotron radiation sources, ALBA is also going through an upgrade project. At the same time, the world of BPM electronic is evolving fast to keep up with the stringent requirement of new facilities. In order to follow the situation closely and develop know-how for the future, we decided to install and test in our storage ring a BPM readout system composed by a Pilot-Tone generator (developed by Elettra) and a modified Libera Spark (by Instrumentation Technologies). We compare position measurement results and stability with the ones obtained by our standard Libera Brilliance and a Libera Brilliance+ electronics.

INTRODUCTION

As other third generation Synchrotron Light Sources, ALBA [1] is also starting its upgrade project which will lead to the new ALBA-II machine [2]. In this frame, an upgrade of the BPMs readout system, composed nowadays by Liberas Brilliance [3], will be needed and, for this reason, alternative electronics are being studied. In particular, the system proposed by ELETTRA in collaboration with I-Tech has been tested at ALBA storage ring. The system is based on the idea of using a Pilot-Tone signal (PT) to calibrate online fluctuations related to external factor acting on cables and readout electronics [4].

This method is intended to avoid the use of quasi-crossbar switches which are now running in Libera Brilliance and Libera Brilliance+ electronics to minimize effects of the electronics on the beam measurement [3]. Main disadvantages of this compensation technique are that:

1. signal pollution due to cables is not kept into account for the compensation;
2. the switching mechanism generates glitches in the Fast Signal and might compromise the final position measurement.

Both these disadvantages may be solved using the PT method.

PILOT-TONE + LIBERA SPARK

The system is composed by a PT generator and a modified Libera Spark. The PT generator produces a sinusoidal RF signal at a frequency close to the RF frequency. The PT signal is injected after each BPM buttons in order to pass along all the electronics path.

The idea is that, since the beam and the PT frequencies are similar, any fluctuation induced by variation in the electronics path will be similar for both signals. Moreover, since

frequencies are slightly different, it is possible to separate the responses of the two signals thanks to Fourier analysis, and to compensate the Raw Signal coming from the beam with using the one of the PT [5].

The PT generator, designed by ELETTRA, is optimized to produce frequencies close to the 499.65 MHz of ALBA RF frequency. It is powered over Ethernet and can easily be located inside the tunnel and controlled via a Tango device. The signal is splitted and added to the beam signal inside the generator. It is possible to regulate the amplitude of the PT signal in order to have it similar to the one produced by the beam. Also, individual output attenuator can be set for each channel.

The Libera Spark has been modified in order to be able to actually see the PT signal: to do so, saw filters at the entrance of the electronics were removed. As a downside, the removal of these saw filters makes impossible to perform measurements during single bunch operation. Saw filters, apart from filtering, also have the function of spreading the single bunch signal over several ADC samples. This allows the signal processing for this operation mode, which is not measurable using this technique nowadays.

Libera Spark software has been modified to separate beam and PT signal through Fourier analysis and to finally calculate the compensated data. The device server provided by I-Tech, shows:

- Raw Signal: Sum of PT and Beam signal as passing through the whole electronics.
- PT Signal: PT signal resulting after Fourier analysis of the Raw Signal inside the Libera.
- Compensated Signal: obtained by compensating the Raw Signal using the PT one.

At ALBA the RF frequency is 499.654 MHz. The PT frequency is set to be 501.41 MHz. The ADC of the modified Spark, adjusted for ALBA, under-samples these signals with a frequency of 118.2217 MHz. The resulting intermediate frequencies for the beam and the PT are $if_{RF} = 26.76$ MHz and $if_{PT} = 28.52$ MHz. The plot of the Fourier transform of the Raw Signal for each of the four BPMs buttons is presented in Fig. 1, two main peaks are present at if_{RF} and if_{PT} .

CONFIGURATION

The PT generator has been located in the tunnel and connected to a spare BPM. In order to have consistent results, data has been compared to the one obtained from a second and a third BPM connected respectively to a Libera Brilliance and a Libera Brilliance+.

* Itorino@cells.es

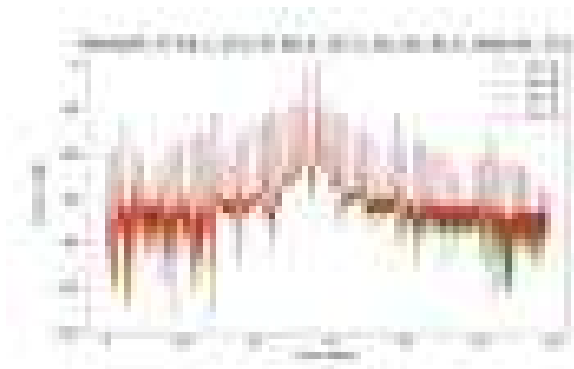

Figure 1: Spectrum of the signal read by the Libera Spark for each BPM button. Two main peaks are present: the beam intermediate frequency and the one of the PT signal.

All these BPMs are not in the Fast Orbit Feedback loop and are in the same sector (SR07). In particular BPMs connected to the Libera Brilliance+ and to the PT-Libera Spark (BPMSR0709 and BPMSR0710) are respectively before and after a free straight section, while the one connected to a Libera Brilliance is in the middle of the arc (BPMSR0704). One meter long cables are used to connect the BPM buttons to the PT generator while standard 20 m cables are used to bring the signal of all BPMs outside the tunnel. All electronics are located in the same rack where a temperature and humidity sensor is also present. A schematic of the configuration is presented in Fig. 2.

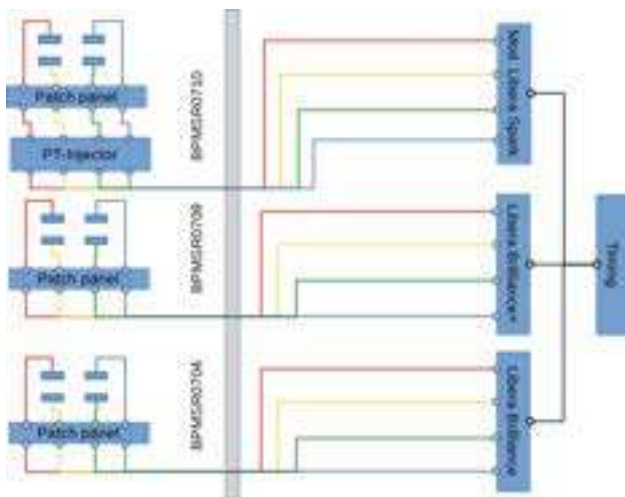

Figure 2: Schematic of the different readout system distribution.

Data is stored at 1 Hz during several user operation runs as well as during dedicated machine days. For each readout setup we save the raw data (VA , VB , VC , and VD) and horizontal and vertical position.

In case of the PT-Libera Spark system, Raw, PT, and Compensated data sets are saved.

STANDARD OPERATION

Data taken during standard operation are useful to verify the stability of the measurement and the capability of the PT technique of compensating drifts in the measurements not related with machine events.

Horizontal and vertical position data from an entire run of user operation is presented in Fig. 3: compensated data from the PT-Libera Spark system in blue, Libera Brilliance in red and Libera Brilliance+ in violet. Jumps in the Libera Brilliance horizontal positions (top plot) happen after machine days each Monday. This are due to different settings of the machine: the Libera Brilliance is connected to a BPM which is located in the middle of the girder in between different magnets and far from FOFB BPMs and correctors.

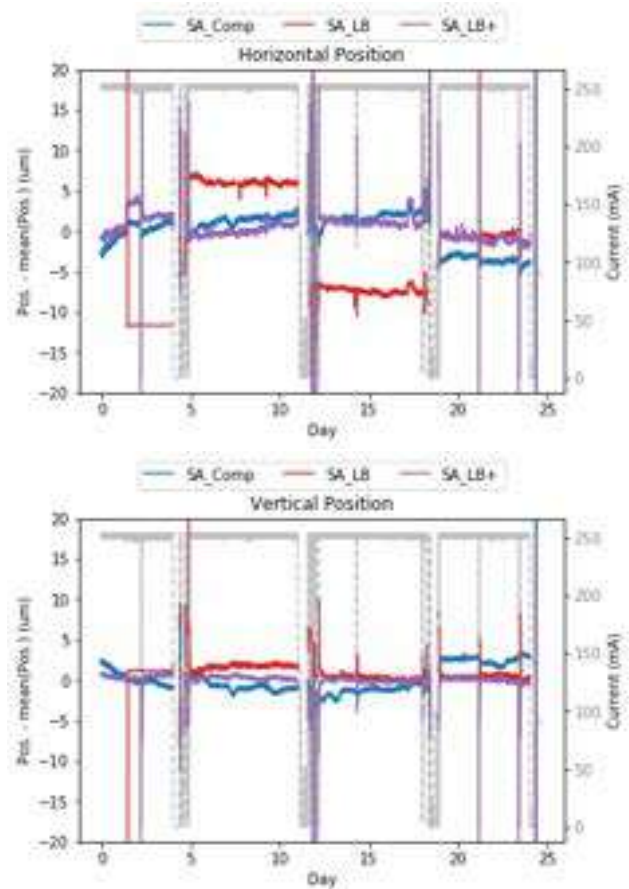

Figure 3: Horizontal (top) and vertical position (bottom) data from the PT-Libera Spark (blue), Libera Brilliance (red), Libera Brilliance+ (violet).

From the plot, it is possible to realize that the best long term stability is the one obtained with the Libera Brilliance+, while some drifts can be observed in data acquired using the PT-Libera Spark system. Since BPMs connected to this electronics are before and after an empty straight session, the behavior of position data should be the same. However, it is interesting to notice that the PT is well compensating fluctuation due to temperature in the rack. Considering the

Content from this work may be used under the terms of the CC BY 3.0 licence (© 2021). Any distribution of this work must maintain attribution to the author(s), title of the work, publisher, and DOI

PT Correction Signal for each button, one can notice a clear correlation with the temperature, as presented in Fig. 4.

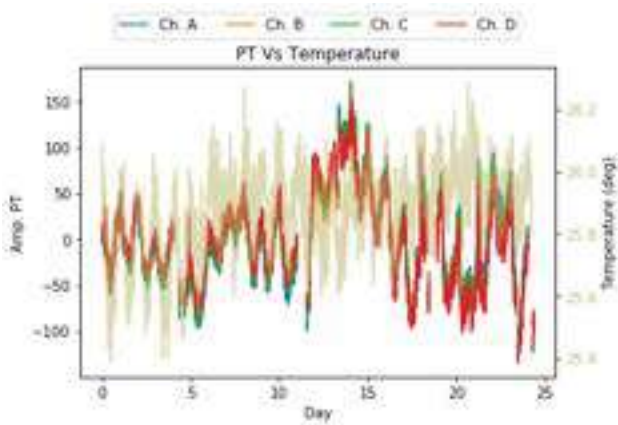

Figure 4: PT compensation data for each BPM button and temperature in the rack.

The work of the PT compensation can also be appreciated looking at the different kind of position data provided from the PT-Libera Spark system. As an example, vertical data during one day, presented in Fig. 5, shows a step in both Raw Signal (SA, in orange), and in the PT compensation (SA_PT, in green). As a result, the compensated data (SA_Comp, in blue) does not show any step.

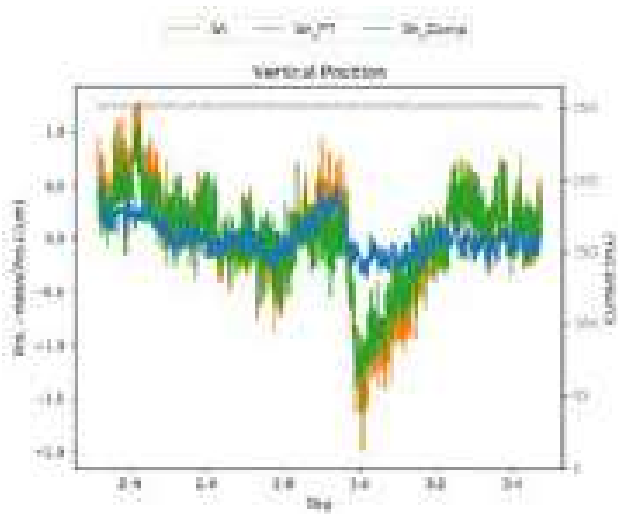

Figure 5: Vertical position data from the PT-Libera Spark system. Raw data (SA, in orange) are compensated by the PT compensation signal (SA_PT, green). The compensated data (SA_Comp, blue) does not show any perturbation.

Figure 6 shows instead the same set of data for the second week of the run presented in Fig. 3. An offset of 5 μm has been added to separate the curves. It is clear that compensated data have a smaller standard deviation with respect to uncompensated one. Also, some perturbations are present in the raw data (in orange) around day 4. The PT compensation (green) follows a similar behavior, meaning that the perturbation is not coming from the beam. Compensated

data are then flat. On the other hand no compensation has been applied to the bump present between days 1 and 2. This might be related to beam motion.

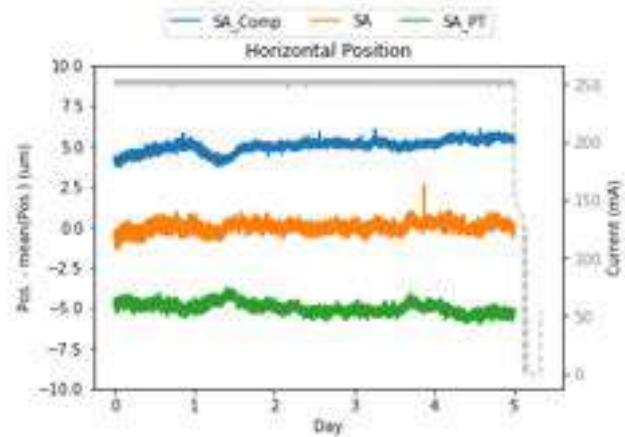

Figure 6: Horizontal position data from the PT-Libera Spark system. Note the PT actuating around day 4.

DIFFERENT FILLING PATTERNS

During machine dedicated time, different Filling Patterns (FPs) were injected in the storage ring. The idea was to see how the measured position and stability changed when changing the bunch distribution.

ALBA longitudinal structure is composed by 448 buckets. Three different FP were tested:

- Standard ALBA FP: First 440 buckets are filled and the last 48 are empty (98% of filled buckets);
- Eight trains: eight trains of 45 consecutive bunches, in between each train a gap of 11 empty buckets is present (80% of filled buckets);
- One-Third: Only 1/3 consecutive buckets are filled (33% of filled buckets).

As an example the ADC data of the One-Third FP is shown in Fig. 7. The buffer roughly covers three turns. It is clear that the gap is not empty but is filled by the PT-signal.

To have comparable data between different FPs, the current was fixed at 150 mA. The PT amplitude has been adjusted in order to maintain the same level of beam and PT signal.

For each FP, the position and the RMS over one hour data acquisition have been measured, after waiting for an additional hour to reach thermal stabilization. The position obtained using the standard FP has been used as a reference.

Figure 8 shows the position measured for each FP. Data shows a repeatability of the position measurement using different FP within 3 μm . The One-Third FP shows worst results for all electronics, this is due to the fact that only the 33% of buckets were filled, leading to a larger contribution of noise.

RMS of the position measurement, presented in Table 1, shows that, over the chosen time range, PT stability results



Figure 7: ADC data for the One-Third FP. The buffer covers three turns.

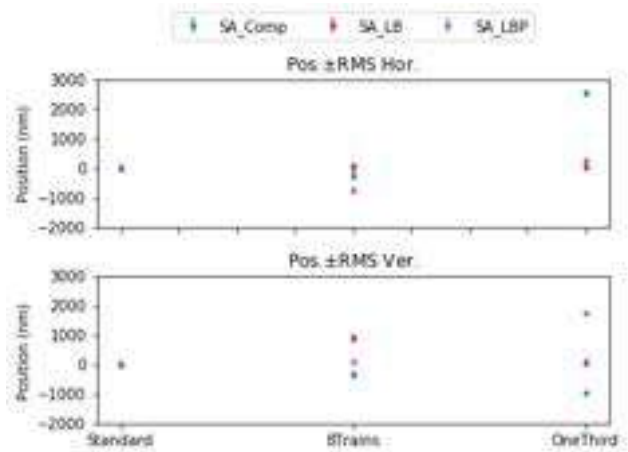

Figure 8: Positions for different FP measured with different electronics: PT-Libera Spark (blue), Libera Brilliance (red), Libera Brilliance+ (violet).

are comparable with the ones obtained with the Libera Brilliance+.

CONCLUSION

A PT-Libera Spark system has been installed and tested at the ALBA storage ring. Data taken during standard operation as well as in machine days proves that the PT compensation system is performing well to cure perturbation related with the cable/electronic path. Long term data indicates a slight tendency to drift in position while the position and stability

Table 1: SA Data RMS over One Hour Acquisition for Different FP

Fill. Pattern	RMS (nm)		
	Spark+PT	Brilliance	Brilliance+
Standard Hor.	121	141	123
Standard Ver.	92	143	70
8-Trains Hor.	149	147	125
8-Trains Ver.	115	153	61
1/3 Hor.	86	115	87
1/3 Ver.	70	116	82

obtained in the one hour time range show performances which are comparable to the one obtained with the Libera Brilliance+.

ACKNOWLEDGEMENTS

Authors would like to thanks G. Brajnik (ELETTRA) and P. Leban (I-Tech) for the technical suport. Many thanks to R. Brouquart (Soleil) for providing the the PT generator device server.

REFERENCES

- [1] F. Perez, “First Year Operation of the ALBA Synchrotron Light Source”, in *Proc. 4th Int. Particle Accelerator Conf. (IPAC’13)*, Shanghai, China, May 2013, paper MOPEA055, pp. 202–204.
- [2] G. Benedetti, M. Carlà, U. Iriso, Z. Martí, and F. Perez, “A Distributed Sextupoles Lattice for the ALBA Low Emittance Upgrade”, presented at the 12th Int. Particle Accelerator Conf. (IPAC’21), Campinas, Brazil, May 2021, paper WEPAB074.
- [3] P. Leban, “Libera Brilliance User Manual”, 2009.
- [4] P. Leban, G. Brajnik, and R. De Monte, “Evaluation of Pilot-Tone Calibration Based BPM System at Elettra Sincrotrone Trieste”, in *Proc. 10th Int. Particle Accelerator Conf. (IPAC’19)*, Melbourne, Australia, May 2019, pp. 2638–2640. doi:10.18429/JACoW-IPAC2019-WEPGW072
- [5] G. Brajnik, S. Carrato, S. Bassanese, G. Cautero, and R. De Monte, “A Novel Electron-BPM Front End With Sub-Micron Resolution Based on Pilot-Tone Compensation: Test Results With Beam”, in *Proc. 5th Int. Beam Instrumentation Conf. (IBIC’16)*, Barcelona, Spain, Sep. 2016, pp. 307–310. doi:10.18429/JACoW-IBIC2016-TUPG02