

# RF REFERENCE DISTRIBUTION AND TIMING SYSTEM FOR THE TAIWAN PHOTON SOURCE

C. Y. Wu, Jenny Chen, K. H. Hu, Y. S. Cheng, P. C. Chiu, Y. T. Chang, C. Y. Liao,  
C. H. Kuo, K. T. Hsu,  
NSRRC, Hsinchu 30076, Taiwan

## Abstract

Taiwan Photon Source (TPS) is a low-emittance 3-GeV synchrotron light source with circumference of 518.4 m which is being under construction at National Synchrotron Radiation Research Center (NSRRC) campus. A novel fiber based on 500 MHz RF reference distribution system will be employed. Timing system for the TPS will be an event based system. It is based on 6U CompactPCI form factor event generator and receivers. Prototype of the RF distribution and event system are on progress. The preliminary test results of the prototype will be summarized in this report.

## INTRODUCTION

The TPS is the latest generation synchrotron light source. To take advantage of various development in the last decade, the transfer of continue wave (CW) RF reference and timing will be based on optical technology [1-3]. RF reference would need distributed to RF systems of linear accelerator (linac), booster synchrotron, the storage ring and diagnostic stations with phase stabilize, low additive phase noise and could counteract the effects of ambient temperature change. It was decided to adopt fiber based distribution solution which is commercial available to avoid bulky coaxial cable installation. Event based timing system is applied for TPS due to its high performance and flexibility which has been already verified in many advanced light sources [4].

## RF REFERENCE DISTRIBUTION

The RF reference will adopt newly developed fiber based RF CW transfer system. This is commercial available Libera Sync which assures clock signal distribution with femtosecond jitter and fiber drift compensation. It is suitable for FEL and synchrotron light source machines. The principle of the Libera Sync is shown in Fig. 1. Group delay of the RF signal in the clock distribution system is stabilized by the wavelength tuning and the chromatic dispersion of the optical fiber in the forward and the backward direction. The wavelength tuning is operated by means of control temperature of the DFB laser with integrated InP Mach-Zehnder interferometer modulator. The first arrival Libera Sync has been tested as shown in Fig. 2. The distribution of the RF reference for the TPS project is shown in Fig. 3. The prototype is under testing. The only concern is the lifetime of DFB laser, since it adopts telecom grade products, more than 10 years mean time between failures will not cause problem for the light sources operation. Health conditions of fiber links are also monitored by the

control system and machine monitoring system. Any failures of a link will be identified instantaneously for immediate spare unit replace and affect machine availability as less as possible.

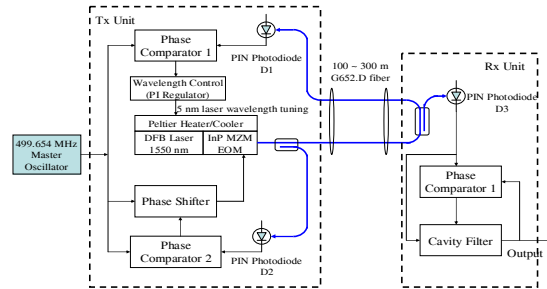

Figure 1: Simple block diagram of the Libera Sync for 500 MHz operation.



Figure 2: Photograph of Libera Sync transmitter and receiver pairs.

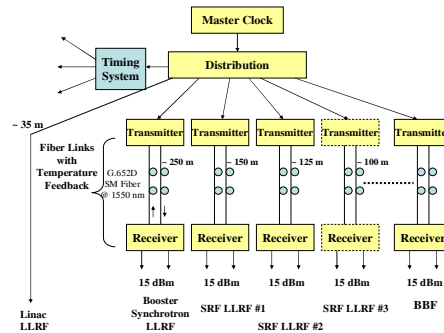

Figure 3: RF reference distribution scheme for the TPS.

## TIMING SYSTEM

The TPS timing system is an event based system. A central event generator (EVG) generates events from an internal sequencer and external sources [5]. These events are distributed over optic fiber links to multiple event receivers (EVRs) [6]. The EVRs, which are located in the control system interface layer, decode the events referred

to as hardware triggers or software interrupts. Hardware triggers are connected directly to the equipment using copper or optic fiber connections when a better timing resolution is required. For the linac, the decoded events are further encoded by a gun transmitter and sent over a fiber link to the gun high voltage platform. The external event sources include PPS signal which is locked to GPS, a mains 60 Hz trigger, post-mortem trigger after beam loss and machine protection system trip. The event clock is derived from the 499.654 MHz master oscillator so that it is locked to change in the RF frequency. The structure is shown in Fig. 4. The master oscillator can be used an external reference from a GPS disciplined Rubidium 10 MHz clock. Fig. 5 shows TPS timing modules include EVG, EVR, EVRTG and linac gun trigger receiver.

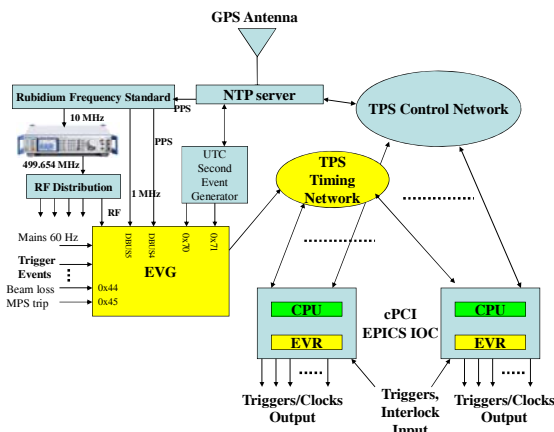

Figure 4: Block diagram of the TPS event system.

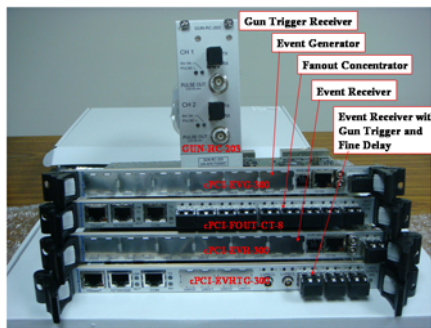

Figure 5: TPS timing modules.

### Event Generator

The cPCI-EVG-300 generates event frames consisting of an 8-bit event code and an 8-bit distributed data bus, at a rate of 125 MEvents/sec. Events can originate from several sources including: eight external trigger events, a sequence RAM, software events and events received from an upstream event generator. Events from different sources have different priorities which are resolved in a priority encoder. A block of RAM is used to store a sequence of events. In cPCI-EVG-300 the input RF clock (499.654 MHz) is divided by 4 to generate the event clock for the TPS timing system. Therefore, the resolution of timing event is 8 ns. The 8-bit distributed data bus signals are sampled simultaneously at the event clock rate and

distributed to the event receivers. The cPCI-EVG-300 is realized as a 6 U CompactPCI (cPCI) module.

### Event Receiver

The cPCI-EVR-300 recovers the event clock signal from the event stream and splits the event frame into the 8-bit event code and the 8-bit distributed data bus. The decoded events are mapped through RAM on to: trigger twelve pulse generators with programmable delay and width (32-bit prescaler from the event clock, 32-bit delay and 32-bit width) or set/reset twelve pulse generators. The cPCI-EVR-300 provides 3 programmable 16bit prescaler from the event clock. The processed events can produce hardware outputs or software interrupts and are time-stamped with a resolution of 8 ns. The twelve front panel outputs can be mapped to any output such as each pulse generator output, prescaler and distributed bus bit. The cPCI-EVR-300 is realized as 6U cPCI module.

### Event Receiver with Linac Gun Driver Capability

The cPCI-EVRTG-300 has two SFP ports that can generate modulated optical signals that can be decoded by the GUN-RC-203 for linac gun driver trigger. The two SFP ports share an external inhibit signal. To allow SFP ports output pulses, the inhibit signal has to be pulled low. The GUN-RC-203 consists of two channels to provide single-bunch and multi-bunch injection respectively by driving separate gun triggers. It is realized as a cPCI-EVRTG-300 in the Linac timing crate and a GUN-RC-203 placed on the gun HV platform. The fine programmable delay is also available and allowed to adjust the triggering position with a resolution of 10 ps over a range of 10 ns. The GUN-TX-203 mode has been designed to operate output pulse delayed by 1/4, 2/4 and 3/4 event clock period (~2, 4, 6 ns).

### Distribution

The timing distribution network delivers the event stream using OM3 multi-mode fiber. The network is structured as a three-level multi-star topology using 29 fan-out concentrator modules these operate as a one in - eight out fan-out. EVG to multiple EVRs is arranged by using fibers of equal lengths,  $410 \text{ m} \pm 0.2 \text{ m}$ .

## EVENT GENERATION

The TPS storage ring has 864 buckets with revolution frequency of 578.303 kHz, and the booster 828 buckets and a revolution frequency of 603.445 kHz. The coincidence of the SR and booster revolution determines a frequency for the coincidence clock of 25.14 kHz, based on the common factors of the two frequencies. The event clock is used for counting through the EVG sequence RAM, which provide 8 ns resolution. The coincidence clock synchronizes the machine repetition rate which is derivate from AC mains frequency and used to reset the start of the sequence, thereby locking the cycles of all

accelerators. Event entries are placed in the sequence RAM to generate the necessary sequence of triggers to accelerate the electrons through the linac and booster into the SR. Additional events provide trigger of the TPS diagnostics, gating signals for beamline in top-up operation, and beam loss post-mortem.

**SOFTWARE**

The timing system integrates into the TPS EPICS control environment. The EVG configuration pages define the options of cPCI-EVG-300. These include configuration of the EVG operating mode, selection of RF and AC divider, definition of multiplexed counter, optional transmission of software events, enable of event trigger inputs and specify event code and timestamp into the sequence RAMs. The EVR configuration pages configure the options for the cPCI-EVR-300, such as pulse delay, width and polarity, front panel output assignments and distributed bus enable and event decoding mapping RAMs. Applications to control the timing system are built with the usual EPICS tools for databases and EDM for user interface. The EVG/EVR configuration GUI is shown in Fig. 6.

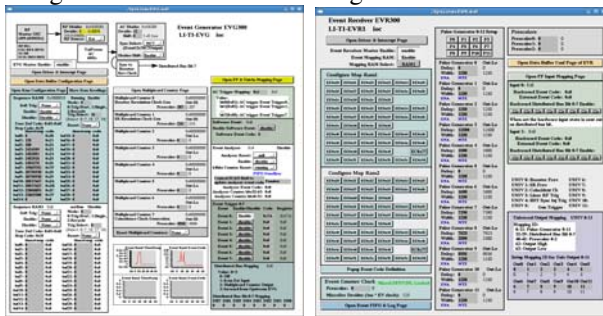

Figure 6: EVG/EVR configuration GUI.

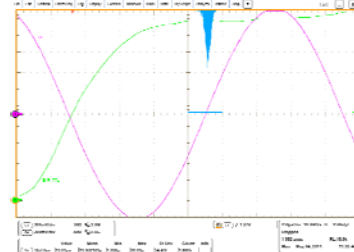

Figure 7: Prototype of timing summary control page.

**CURRENT STATUS**

The first lot of EVG/EVR modules was received in December 2010. Setup of the test system has been started from February 2011. Configuration tools for the EVG/EVRs were implemented. Timing for the linac RF trigger and e-gun trigger are ready for operation which is required for the commissioning of the TPS 150 MeV linac started from April, 2011. Prototype of timing summary control page is shown in Fig. 7. The timing jitter of the

installed prototype system of the decoded event with TTL output respect to the RF clock is around 20 ps for the cPCI-EVR-300 as shown in Fig. 8 (a). The jitter of the beam relative to the RF source is less than 10 ps for the cPCI-EVRTG-300 with GUN-RC-203 module as shown in Fig. 8(b).



(a)

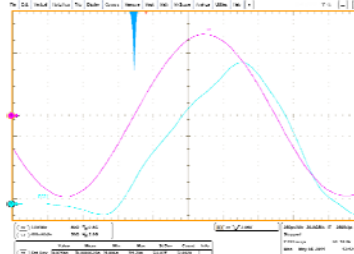

(b)

Figure 8: (a) Jitter of the cPCI-EVR-300 TTL output relative to the RF clock and (b) Jitter of the beam relative to the RF clock. The beam is triggered by combination of the cPCI-EVRTG-300 and GUN-RC-203 trigger module.

**ACKNOWLEDGEMENT**

Help from experts of Instruments Technologies related to the fiber based RF reference distribution are also highly appreciated. The authors thanks help from many experts on the timing system especially Yuri Chernousko of the DLS, Furukawa of the KEK, Jukka Pietarinen of the MRF.

**REFERENCE**

- [1] J. Tratnik, et al., "Femtosecond Electro-Optical Synchronization System over Distance up to 300 m", Proc. of FEL2009, Liverpool, UK., FROA03, p. 772-775.
- [2] J. Tratnik, et al., "Femtosecond Electro-Optical Synchronization System with Long-term Phase Stability Results", Proc. of IPAC10, Kyoto, Japan, WEPEB080.
- [3] J. Tratnik, et al., "Electro-Optical Synchronization System with Femtosecond Precision", Proc. of OSA/OFC/NFOEC 2010, San Diego, CA, U.S.A. OThH4.
- [4] Y. Chernousko, et al., "Review of the Diamond Light Source Timing System", Proc. of RuPAC-2010, Protvino, Russia. pp. 144-146.
- [5] Micro-Research Finland Oy, "Event Generator", Document: EVG-MRM-0003, 4 January 2011.
- [6] Micro-Research Finland Oy, "Event Receiver – Technical Reference", Document: EVR-MRM-003, 7 April 2011.